

OIL-LESS PISTON VACUUM PUMPS & COMPRESSORS

OPERATION & MAINTENANCE MANUAL



Model 1HAB Shown



Model 3HBB Shown



Model 3HEB Shown



Model PCD Shown

Thank you for purchasing this Gast product. It is manufactured to the highest standards using quality materials. Please follow all recommended maintenance, operational and safety instructions and you will receive years of trouble free service.

IMPORTANT: PLEASE READ THIS MANUAL AND SAVE FOR FUTURE REFERENCE.

Product Use Criteria:

- Pump only clean, dry air.
- Operate at 32°F - 104°F (0°C - 40°C).
- Protect unit from dirt & moisture.
- Do not pump flammable or explosive gases or use in an atmosphere that contains such gases.
- Protect all surrounding items from exhaust air. This exhaust air can become very hot.
- Corrosive gases and particulate material will damage unit. Water vapor, oil-based contaminants or other liquids must be filtered out.
- Consult your Gast Distributor/Representative before using at high altitudes.
- These pumps are oil-less and require NO lubrication. The Teflon-filled rings are self-lubricating and require no oil.
- The motor bearings are grease-packed for the lifetime of the bearings.



ISO 9001 & 14001 CERTIFIED

www.gastmfg.com

Your safety and the safety of others is extremely important.

We have provided many important safety messages in this manual and on your product. Always read and obey all safety messages.



This is the safety alert symbol. This symbol alerts you to hazards that can kill or hurt you and others. The safety alert symbol and the words "DANGER" and "WARNING" will precede all safety messages. These words mean:

DANGER

You will be killed or seriously injured if you don't follow instructions.

WARNING

You can be killed or seriously injured if you don't follow instructions.

All safety messages will identify the hazard, tell you how to reduce the chance of injury, and tell you what can happen if the safety instructions are not followed.

INSTALLATION

WARNING



Electrical Shock Hazard

Disconnect electrical power at the circuit breaker or fuse box before installing this product.

Install this product where it will not come into contact with water or other liquids.

Install this product where it will be weather protected.

Electrically ground this product.

Failure to follow these instructions can result in death, fire or electrical shock.

Correct installation is your responsibility. Make sure you have the proper installation conditions and that installation clearances do not block air flow.

Lift the unit by the motor shell, motor foot or flywheel (depending upon model design). Do Not lift unit by shroud, filters or mufflers. These parts are not designed to support the weight of the unit.

Blocking air flow over the product in any way can cause the product to overheat.

Install safety guards as required to prevent potential injury hazards or damage to surrounding objects.

Mounting

This product can be installed in any orientation. Mounting the product to a stable, rigid operation surface and using shock mounts will reduce noise and vibration.

Plumbing

Remove plugs from the IN and OUT ports. Connect with pipe and fittings that are the same size or larger than the product's threaded ports. Be sure to connect the intake and exhaust plumbing to the correct inlet and outlet ports. Ports will not support plumbing.

Accessories

If unit will be used in a system where it will be required to start against any system of back pressure, a positive sealing, one-way check valve should be installed in the air line between system and unit. This check valve is included with all tank mounted compressor units.

The product's intake and exhaust filters will provide adequate filtration in most applications. Check filters periodically and replace when necessary. Please consult your Gast Distributor/Representative for additional filter recommendations.

Install relief valves and gauges at inlet or outlet, or both, to monitor performance. Check valves may be required to prevent back streaming through the unit.

Motor Control

It is your responsibility to contact a qualified electrician and assure that the electrical installation is adequate and in conformance with all national and local codes and ordinances. Grounding is required.

Determine the correct overload setting required to protect the motor (see motor starter manufacturer's recommendations). Select fuses, motor protective switches or thermal protective switches to provide protection. Fuses act as short circuit protection for the motor, not as protection against overload. Incoming line fuses must be able to withstand the motor's starting current. Motor starters with thermal magnetic overload or circuit breakers protect motor from overload or reduced voltage conditions.

The wiring diagram supplied with the product provides required electrical information. Check that power source is correct to properly operate the dual-voltage motors.

Electrical Connection

WARNING



Electrical Shock Hazard

This product must be properly grounded.
Do not modify the plug provided. If it will not fit the outlet, have the proper outlet installed by a qualified electrician.
If repair or replacement of the cord or plug is necessary, do not connect the grounding wire to either flat blade terminal. The wire with insulation that is green or green with yellow stripes is the grounding wire.
Check the condition of the power supply wiring. Do not permanently connect this product to wiring that is not in good condition or is inadequate for the requirements of this product.
Failure to follow these instructions can result in death, fire or electrical shock.

Model with a power supply cord:

This product must be grounded. For either 120-volt or 220/240-volt circuits connect power supply cord grounding plug to a matching grounded outlet. Do not use an adapter. (See diagram.)

In the event of an electrical short circuit, grounding reduces the risk of electric shock by providing an escape wire for the electric current. This product may be equipped with a power supply cord having a grounding wire with an appropriate grounding plug. The plug must be plugged into an outlet that is properly installed and grounded in accordance with all local codes and ordinances.

Check with a qualified electrician or serviceman if the grounding instructions are not completely understood, or if you are not sure whether the product is properly grounded. Do not modify the plug provided. If it will not fit the outlet, have the proper outlet installed by a qualified electrician.

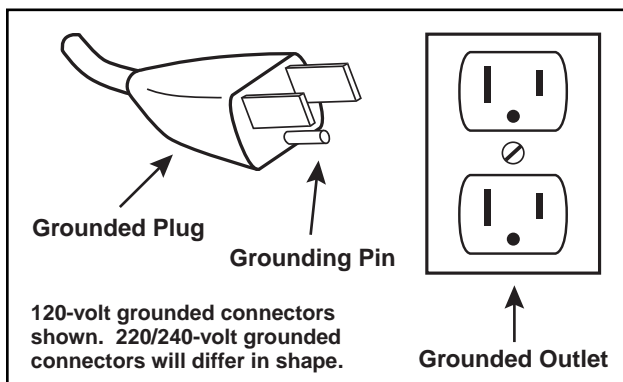

Model that is permanently wired:

This product must be connected to a grounded, metallic, permanent wiring system, or an equipment grounding terminal or lead on the product.

Power supply wiring must conform to all required safety codes and be installed by a qualified person. Check that supply voltage agrees with that listed on product nameplate.

Extension cords:

Use only a 3-wire extension cord that has a 3-blade grounding plug. Connect extension cord plug to a matching 3-slot receptacle. Do not use an adapter. Make sure your extension cord is in good condition. Check that the gage wire of the extension cord is the correct size wire to carry the current this product will draw.

An undersized cord is a potential fire hazard, and will cause a drop in line voltage resulting in loss of power causing the product to overheat. The following table indicates the correct size cord for length required and the ampere rating listed on the product nameplate. **If in doubt, use the next heavier gage cord. The smaller the gage number, the heavier the wire gage.**

Minimum gage for extension cords										
Amps	Volts	Length of cord in feet								
	120v	25	50	100	150	200	250	300	400	500
	240v	50	100	200	300	400	500	600	800	1000
0-2		18	18	18	16	16	14	14	12	12
2-3		18	18	16	14	14	12	12	10	10
3-4		18	18	16	14	12	12	10	10	8
4-5		18	18	14	12	12	10	10	8	8
5-6		18	16	14	12	10	10	8	8	8
6-8		18	16	12	10	10	8	6	6	6
8-10		18	14	12	10	8	8	6	6	4
10-12		16	14	10	8	8	6	6	4	4
12-14		16	12	10	8	6	6	6	4	2
14-16		16	12	10	8	6	6	4	4	2
16-18		14	12	8	8	6	4	4	2	2
18-20		14	12	8	6	6	4	4	2	2

OPERATION

WARNING

Injury Hazard

Install proper safety guards as needed.
Keep fingers and objects away from openings and rotating parts.
When provided, motor terminal covers must be in place for safe operation.
Product surfaces become very hot during operation, allow product surfaces to cool before handling.
Air stream from product may contain solid or liquid material that can result in eye or skin damage, wear proper eye protection.
Wear hearing protection. Sound level from motor may exceed 70 dBA.
Failure to follow these instructions can result in burns, eye injury or other serious injury.

It is your responsibility to operate this product at recommended pressures or vacuum duties and room ambient temperatures. Do not start against a vacuum or pressure load. Do not remove relief valve head while unit is operating.

Start Up

If motor fail to start or slows down significantly under load, shut off and disconnect from power supply. Check that voltage is correct for motor and that motor is turning in the proper direction. If the motor is turning in the wrong direction, it will overheat.

MAINTENANCE

WARNING

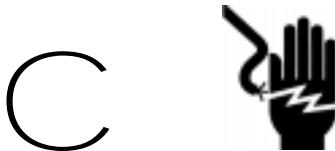

Electrical Shock Hazard

Disconnect electrical power supply cord before performing maintenance on this product.

If product is hard wired into system, disconnect electrical power at the circuit breaker or fuse box before performing maintenance on this product.

Failure to follow these instructions can result in death, fire or electrical shock.

WARNING

Injury Hazard

Product surfaces become very hot during operation, allow product surfaces to cool before handling.

Air stream from product may contain solid or liquid material that can result in eye or skin damage, wear proper eye protection.

Failure to follow these instructions can result in burns, eye injury or other serious injury.

It is your responsibility to:

- Regularly inspect and make necessary repairs to product in order to maintain proper operation.
- Make sure that pressure and vacuum is released from product before starting maintenance.

If unit is operated at maximum duties in a fairly clean, 65°F - 75°F (18°C - 24°C) ambient environment with 35% relative humidity, complete first inspection and maintenance after 4000 hours of operation. Earlier maintenance may be required depending upon the environment.

Check intake and exhaust filters after first 500 hours of operation. Clean filters and determine how frequently filters should be checked during future operation. This one procedure will help assure the product's performance and service life.

Check the thickness of the rider ring. It should measure greater than .055". Change all rings if thickness measures .055" or less.

1. Disconnect electrical power supply to unit.
2. Vent all air lines.
3. Remove filter cover.
4. Check filter felt. Replace felt if it is covered with contamination or shows signs of increasing differential pressure.
5. Reinstall felt and filter cover.

Check that all external accessories such as relief valves and gauges are attached and are not damaged before re-operating product.

Pressure or Vacuum Tank Systems

Check the air filter cartridge. A dirty filter restricts air flow and causes unit to run hotter resulting in longer operating cycles.

Check the air receiver for moisture regularly. The humidity in the environment will determine how quickly moisture will accumulate and need to be drained.

Clean the pump and motor regularly. Dirt and film buildup on the outer shell affects the unit's ability to dissipate heat.

SHUTDOWN PROCEDURES

It is your responsibility to follow proper shutdown procedures to prevent product damage.
NEVER ADD OIL TO THIS OIL-LESS PUMP.

Proper shutdown procedures must be followed to prevent pump damage. Failure to do so may result in premature pump failure. Gast Manufacturing Oil-Less Piston Vacuum Pumps and Compressors are constructed of ferrous metals or aluminum which are subject to rust and corrosion when pumping condensable vapors such as water. Follow the steps below to assure correct storage and shutdown between operating periods.

1. Disconnect plumbing.
2. Operate product for at least 5 minutes without plumbing.
3. Run at maximum vacuum for 10 - 15 minutes.
4. Repeat step 2.
5. Disconnect power supply.
6. Plug open ports to prevent dirt or other contaminants from entering product.

SERVICE KIT INSTALLATION

WARNING

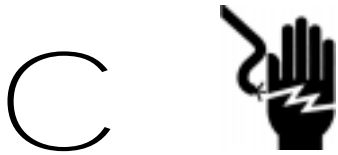

Electrical Shock Hazard

Disconnect electrical power supply cord before installing Service Kit.

If product is hard wired into system, disconnect electrical power at the circuit breaker or fuse box before installing Service Kit.

Vent all air lines to release pressure or vacuum.

Failure to follow these instructions can result in death, fire or electrical shock.

Gast will NOT guarantee field-rebuilt product performance. For performance guarantee, the product must be returned to a Gast Authorized Service Facility.

Service Kit contents vary. Most contain head and cylinder gaskets, valves, piston rings and seals, rider rings and felt filters.

1. Disconnect electrical power to pump.
2. Disconnect air supply and vent all air lines to release pressure or vacuum.
3. Remove shroud, cylinder head and valve components.
4. Remove cylinder and rings.
5. Clean all parts with water or non-petroleum based solvent such as Gast AH255B Solvent. Do Not use kerosene or ANY other combustible solvents.
6. Install piston seals, piston rings and rider rings on piston. Locate ring joints approximately opposite each other.
7. Use cylinder screws with washers to attach cylinder to bracket. Tighten screws only until they are finger tight.
8. Move pistons to top dead center position. Adjust each cylinder flush with top of piston.
9. Torque cylinder screws to 150-160 in. lbs.
10. Replace valve components in original order.
11. Install cylinder head and head screws. The exhaust ports have been marked on the cylinder heads by omitting the ends of two of the fins. Do not tighten screws at this time.
12. Install manifold nuts and seals on manifold. Insert into cylinder head and manifold.
13. Torque head screws to 150-160 in. lbs.
14. Turn fan by hand to check that rod assembly is not hitting head. If rod hits head, loosen cylinders and adjust.
15. Install manifold and tighten manifold nut one-quarter to one-half turn beyond finger tight.
16. Operate unit for 10 minutes. Tighten screws again.
17. Install fan shroud.

Check that all external accessories such as relief valves and gauges are attached to cover and are not damaged before re-operating product.

If pump still does not produce proper vacuum or pressure, send unit to a Gast Authorized Service Facility for repair.

SPECIFIC PROBLEMS AND REMEDIES

Unit stalls after vacuum or pressure starts building up in receiver:

1. Disconnect electrical power supply from unit.
2. Check that voltage from power source matches that listed on nameplate.
3. Check wiring connections against diagram on nameplate. Single voltage motors will operate only at designated voltage.

Motor will not start:

1. Disconnect electrical power supply from unit.
2. Check that voltage from power source matches that listed on nameplate.
3. Check wiring connections against diagram on nameplate. Single voltage motors will operate only at designated voltage.
4. Reconnect electrical supply to unit. Check that power is on. If extension cord is used, check that it is the correct size and length to adequately supply power to the unit.
5. If unit will still not operate, contact your Gast Distributor/Representative or a Gast Authorized Service Facility.

Motor starts at 0 PSI but will not start under pressure:

1. Replace the check valve.
2. Wait for the thermal overload switch to reset before attempting to operate.
3. If unit will not restart, the thermal overload switch may need to be replaced. If there isn't a thermal overload switch, the motor may be damaged and requires service.

Motor starts intermittently:

1. Disconnect electrical power supply from unit.
2. Check points in the pressure or vacuum switch for wear or dirt.
3. Check for dirt buildup or uneven wear.
4. Replace parts as required.

Unit cycles On-Off more often than when first installed:

1. Check air receiver and drain water that has accumulated.

Unit or motor is running more often than when first installed:

1. Check system for air leaks. If new or different pneumatic equipment has been added, the air requirements may have changed.
2. Check and clean filters.
3. Check for buildup of foreign material on head.
4. Check valves and rings for wear and damage.

Air receiver loses pressure:

1. Check for system leaks through pipes, fittings and seals.
2. Inspect the check valve to see if it is allowing air pressure to leak back into unit.
3. Pressure pumps will have bubbles around head assembly during operation. Stop operating the pump for a few minutes and check for air leaks at pump.
4. Vacuum systems should have the check valve removed and inspected for dirt buildup. It may be necessary to need an AV460 filter installed prior to tank to eliminate contaminants.

A leak is located at the unit:

1. Vent all pressure from inside the air receiver until gauge reads 0 PSI.
2. Inspect check valve for dirt buildup, wear and proper operation.
3. Replace check valve if necessary.

PARTS & ORDERING INFORMATION

Please reference the exploded view on the opposite page for the following model and parts table.

1HAA / 1HAB SERIES

REF	DESCRIPTION	QTY	1HAA	1HAB	1HAE	1LAA	1VAF	2HAH	2LAF	3HEB	3HEE	3LEM
1	INLET FILTER ASSEMBLY	1	B300A	B300A	B300A	B300A	B300A	B300A	B300F	B300F	B300F	B300F
2 Δ	FELT	1	B344A	B344A	B344A	B344A	B344A	B344A	B344A	B344A	B344A	B344A
3	SAFETY VALVE	1	AS100E	AS100G	AS100G	AS100C	-	AS100G	AS100C	AS100G	AS100G	AS100C
4	CYLINDER HEAD	1	AF508	AF508	AF508	AF508	AF508	AF508	AF508	AH691	AH691	AH691
5 Δ	HEAD GASKET	1	AF518	AF518	AF518	AF518	AF518	AF518	AF518	AF520A	AF520A	AF520A
6 Δ	OUTLET VALVE	1	AF531	AF531	AF531	AF531	AF531	AF531	AF531	AF545	AF545	AF545
7	PLATE VALVE	1	AF529	AF529	AF529	AF529	AF529	AF529	AF529	AK779	AK779	AK779
8 Δ	INLET VALVE	1	AF530	AF530	AF530	AF530	AF530	AF530	AF530	AF544	AF544	AF544
9 Δ	CYLINDER GASKET	1	AF519A	AF519A	AF519A	AF519A	AF519A	AF519A	AF519A	AF521	AF521	AF521
10	CYLINDER	1	AF510	AF510	AF510	AF510	AF510	AF510	AF510	AF509	AF509	AF509
11 Δ	PISTON RING	2	AF527	AF527	AF527	AF527	AF527	AF527	AF527	AF541	AF541	AF541
12 Δ	PISTON SEAL	2	AF526	AF526	AF526	AF526	AF526	AF526	AF526	AF540	AF540	AF540
13 Δ	RIDER RING	1	AF594	AF594	AF594	AF594	AF594	AF594	AF594	AF595	AF595	AF595
14	PISTON ROD ASSEMBLY	1	AF560A	AF560B	AF560E	AF560A	AF560F	AF560H	AF560F	AK893B	AK893E	AK893M
15	COUNTER WEIGHT	1	AF517A	AF517B	AF517E	AF517A	AF517D	AF517C	AF517D	AT780B	AK780E	AK780A
16	FLAT KEY	1	AF524	AF524	AF524	AF524	AF524	AF524	AF524	AB136	AB136	AB136
17	FAN	1	AF533	AF533	AF533	AF533	AF533	AF547	AF547	AF547	AF547	AF547
18	SHROUD	1	AF534	AF534	AF534	AF534	AF534	AF534	AF534	AT343	AT343	AT343
***	TANK ASSEMBLY	1	-	AF599	-	AF599AA-1	-	AF599	-	-	-	-
***	SERVICE KIT	1	K264	K264	K264	K264	K264	K264	K264	K514A	K514A	K514A

Model 1HAB shown.

*** Item not shown.

Δ Denotes parts included in the Service Kit.

Parts listed are for stock models. For specific OEM models, please consult the factory.

When corresponding or ordering parts, please give complete model and serial numbers.

EXPLODED PRODUCT VIEW - MODEL 1HAB

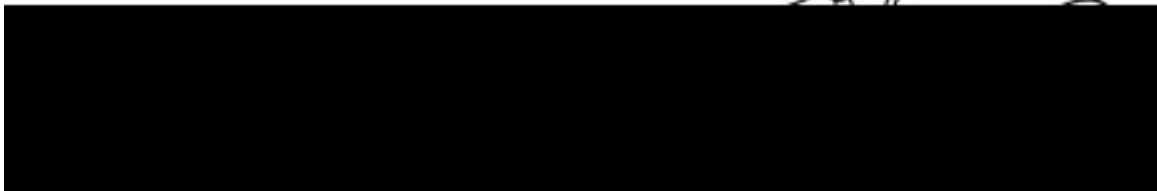
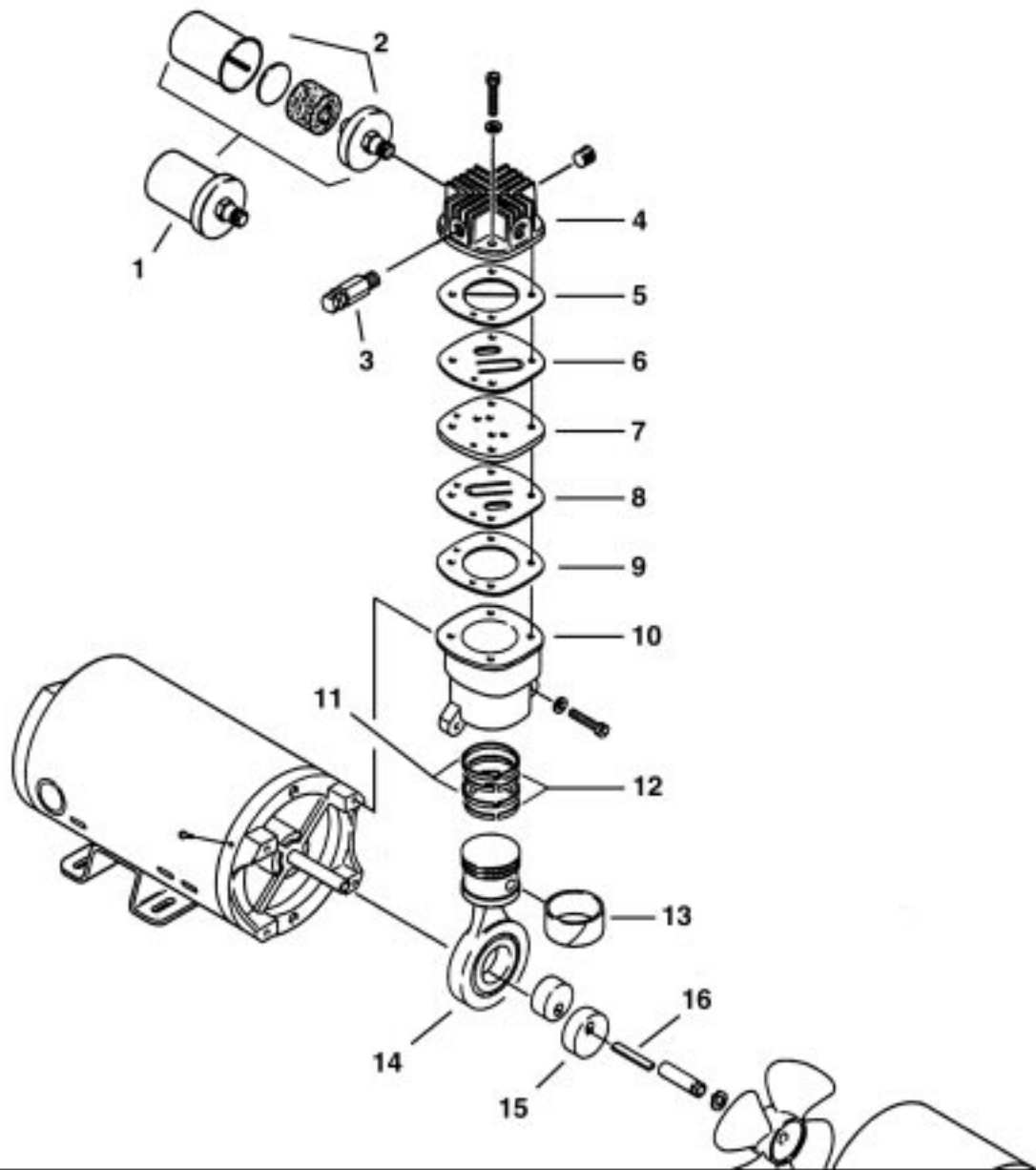

PARTS & ORDERING INFORMATION

Please reference the exploded view on the opposite page for the following model and parts tables.

1VBF – 3LBD SERIES

REF	DESCRIPTION	QTY	1VBF	1VSF	2LBB	2HBB	2HBC	3HBB	3HBE	3LBA	3LBD
1	INLET FILTER ASSEMBLY	1		B300A							
		2	B300A	B300A	B300A	B300A	B300A	B300A	B300A	B300A	B300A
2 Δ	FELT	2	B344A	B344A	B344A	B344A	B344A	B344A	B344A	B344A	B344A
3	SAFETY VALVE	1	-	-	AS100C	AS100G	AS100G	AS100G	AS100G	AS100C	AS100C
4	CYLINDER HEAD	2	AF508	AF508	AF508	AF508	AF508	AF508	AF508	AF508	AF508
5 Δ	HEAD GASKET	2	AF518	AF518	AF518	AF518	AF518	AF518	AF518	AF518	AF518
6 Δ	OUTLET VALVE	2	AF531	AF531	AF531	AF531	AF531	AF531	AF531	AF531	AF531
7	PLATE VALVE	2	AF529	AF529	AF529	AF529	AF529	AF529	AF529	AF529	AF529
8 Δ	INLET VALVE	2	AF530	AF530	AF530	AF530	AF530	AF530	AF530	AF530	AF530
9 Δ	CYLINDER GASKET	2	AF519A	AF519A	AF519A	AF519A	AF519A	AF519A	AF519A	AF519A	AF519A
10	CYLINDER	2	AF510	AF510	AF510	AF510	AF510	AF510	AF510	AF510	AF510
11 Δ	PISTON RING	4	AF527	AF527	AF527	AF527	AF527	AF527	AF527	AF527	AF527
12 Δ	PISTON SEAL	4	AF526	AF526	AF526	AF526	AF526	AF526	AF526	AF526	AF526
13	PISTON ROD ASSEMBLY	2	AF560F	AF560F	AF560B	AF560B	AF560C	AF560B	AF560E	AF560A	AF560D
14 Δ	RIDER RING	2	AF594	AF594	AF594	AF594	AF594	AF594	AF594	AF594	AF594
15	FLAT KEY	1	AF524	AF524	AF524	AF524	AF524	AF524	AH984	AF524	AH984
16	FAN/FAN ASSEMBLY	1	AF533	AF533	AF533	AF533	AF533	AF533	AF547	AF533	AF547
17	SHROUD	1	AF535	AF535	AF535	AF535	AF535	AF535	AF535	AF535	AF535
18 Δ	MANIFOLD SLEEVE	2	AF567A	AF567A	AF567A	AF567A	AF567A	AF567A	AF567A	AF567A	AF567A
***	SERVICE KIT	1	K260	K260	K260	K260	K260	K260	K260	K260	K260

4VCF – 6HCA SERIES

REF	DESCRIPTION	QTY	4VCF	4VSF	4HCJ	4LCB	4HCC	5LCA	5HCD	5HCE	6HCN	6HCA
1	INLET FILTER ASSEMBLY	1		B300F								
		2	B300F		B300A	B300A	B300A	B300F	B300A	B300A	B300F	B300F
2 Δ	FELT	2	B344A	B344A	B344A	B344A	B344A	B344A	B344A	B344A	B344A	B344A
3	SAFETY VALVE	1	-	-	AS100G	AS100D	AS100G	AS100E	AS100H	AS100H	AS100H	AS100H
4	CYLINDER HEAD	2	AF507	AF507	AF507	AF507	AF507	AF507	AF507	AF507	AF507	AF507
5 Δ	HEAD GASKET	2	AF520A	AF520A	AF520A	AF520A	AF520A	AF520A	AF520A	AF520A	AF520A	AF520A
6 Δ	OUTLET VALVE	2	AF545	AF545	AF545	AF545	AF545	AF545	AF545	AF545	AF545	AF545
7	PLATE VALVE	2	AF543	AF543	AF543	AF543	AF543	AF543	AF543	AF543	AF543	AF543
8 Δ	INLET VALVE	2	AF544	AF544	AF544	AF544	AF544	AF544	AF544	AF544	AF544	AF544
9 Δ	CYLINDER GASKET	2	AF521	AF521	AF521	AF521	AF521	AF521	AF521	AF521	AF521	AF521
10	CYLINDER	2	AF509	AF509	AF509	AF509	AF509	AF509	AF509	AF509	AF509	AF509
11 Δ	PISTON RING	4	AF541	AF541	AF541	AF541	AF541	AF541	AF541	AF541	AF541	AF541
12 Δ	PISTON SEAL	4	AF540	AF540	AF540	AF540	AF540	AF540	AF540	AF540	AF540	AF540
13	PISTON ROD ASSEMBLY	2	AF561F	AF561F	AF561J	AF561B	AF561C	AF561A	AF561D	AF561E	AF561N	AF561A
14 Δ	RIDER RING	2	AF595	AF595	AF595	AF595	AF595	AF595	AF595	AF595	AF595	AF595
15	KEY	1	AB136D	AB136D	AB136D	AB136D	AB136D	AB136D	AB136D	AB136D	AB136F	AB136F
16	FAN/FAN ASSEMBLY	1	AF547	AF547	AF547	AF547	AF547	AF547	AF547	AF547	AF547	AF547
17	SHROUD	1	AF549	AF549	AF549	AF549	AF549	AF549	AF549	AF549	AF656	AF656
18 Δ	MANIFOLD SLEEVE	2	AF567A	AF567A	AF567A	AF567A	AF567A	AF567A	AF567A	AF567A	AF567A	AF567A
***	SERVICE KIT	1	K263	K263	K263	K263	K263	K263	K263	K263	K263	K263

Model 1VBF shown.

*** Item not shown.

Δ Denotes parts included in the Service Kit.

Parts listed are for stock models. For specific OEM models, please consult the factory.

When corresponding or ordering parts, please give complete model and serial numbers.

EXPLODED PRODUCT VIEW - MODEL 1VBF

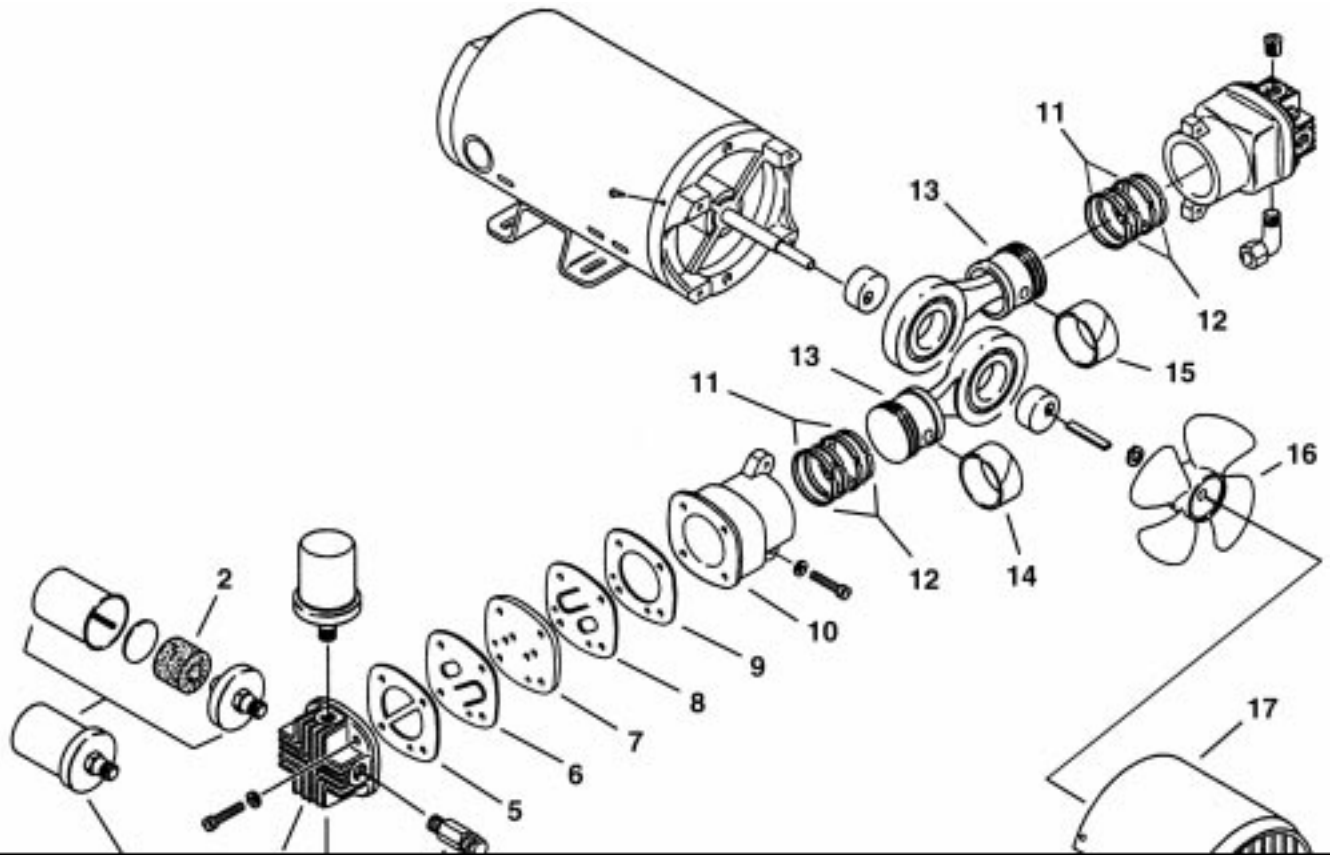

PARTS & ORDERING INFORMATION

Please reference the exploded views on the next page for the following model and parts tables.

PAB – VAB SERIES

REF	DESCRIPTION	QTY	PAB	VAB
1	FILTER ASSEMBLY	1	B300A	B300A
2 Δ	FELT	1	B344A	B344A
3	SAFETY VALVE	1	AS100G	-
4	CYLINDER HEAD	1	AF508	AF508
5 Δ	HEAD GASKET	1	AF518	AF518
6 Δ	OUTLET VALVE	1	AF531	AF531
7	PLATE VALVE	1	AF529	AF529
8 Δ	INLET VALVE	1	AF530	AF530
9 Δ	CYLINDER GASKET	1	AF519A	AF519A
10	CYLINDER	1	AF510	AF510
11 Δ	PISTON RING	2	AF527	AF527
12 Δ	PISTON SEAL	2	AF526	AF526
13 Δ	RIDER RING	1	AF594	AF594
14	PISTON ROD ASSEMBLY	1	AF560B	AF560B
15	PULLEY	1	AB140C	AB140C
15A	COUNTER WEIGHT	1	AF517B	AF517B
16	FLAT KEY	1	AF524	AF524
17	FAN	1	AF533	AF533
18	SHROUD	1	AF534	AF534
***	SERVICE KIT	1	K264	K264

VBB – PCA-10 SERIES

REF	DESCRIPTION	QTY	VBB	VCD	PBB	PCA-10
1	FILTER ASSEMBLY	2	B300A	B300A	B300A	B300F
2 Δ	FELT	2	B344A	B344A	B344A	B344A
3	SAFETY VALVE	1	-	-	AS100G	AS100H
4	CYLINDER HEAD	2	AF508	AF507	AF508	AF507
5 Δ	HEAD GASKET	2	AF518	AF520A	AF518	AF520A
6 Δ	OUTLET VALVE	2	AF531	AF545	AF531	AF545
7	PLATE VALVE	2	AF529	AF543	AF529	AF543
8 Δ	INLET VALVE	2	AF530	AF544	AF530	AF544
9 Δ	CYLINDER GASKET	2	AF519A	AF521	AF519A	AF521
10	CYLINDER	2	AF510	AF509	AF510	AF509
11 Δ	PISTON RING	4	AF527	AF541	AF527	AF541
12 Δ	PISTON SEAL	4	AF526	AF540	AF526	AF540
13	PISTON ROD ASSEMBLY	2	AF560B	AF561D	AF560B	AF561A
14 Δ	RIDER RING	2	AF594	AF595	AF594	AF595
15	PULLEY	1	AB140C	AK670	AB140C	AK670
16	FLAT KEY	1	AF524	AB136	AF524	AB136
17	FAN	1	AF533	AF547	AF533	AF661
18	SHROUD	1	AF535	AF549	AF535	AF656
19	MANIFOLD SLEEVE	2	AF567A	AF567A	AF567A	AF567A
***	SERVICE KIT	1	K260	K263	K260	K263

Models PAB and PBB shown.

** Item not shown.

Δ Denotes parts included in the Service Kit.

Parts listed are for stock models. For specific OEM models, please consult the factory.
When corresponding or ordering parts, please give complete model and serial numbers.

EXPLODED PRODUCT VIEWS - MODEL PAB (TOP) & MODEL PBB (BOTTOM)

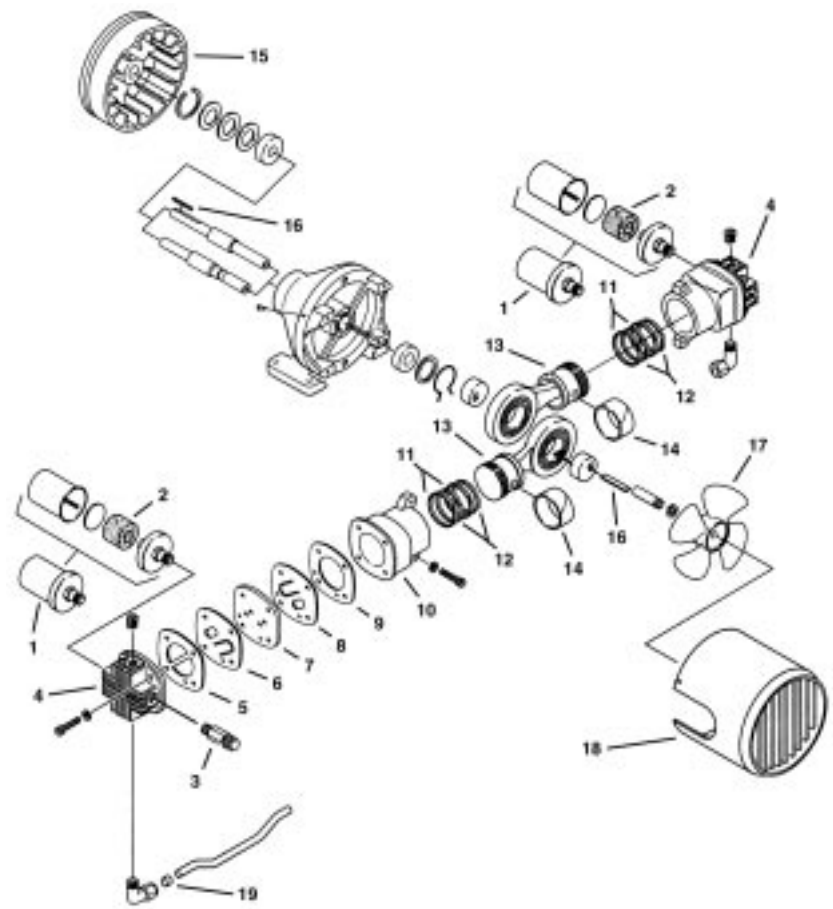
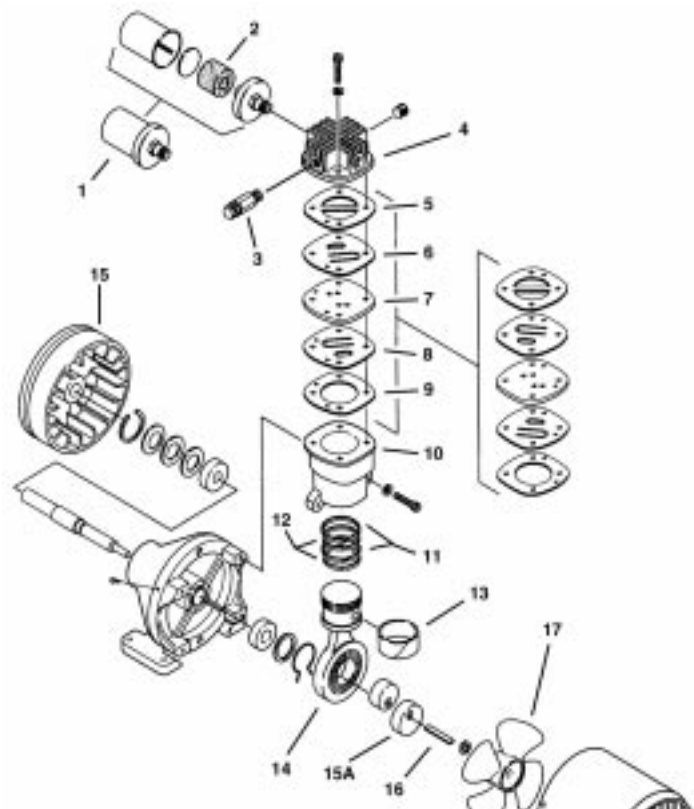

PARTS & ORDERING INFORMATION

Please reference the exploded view on the next page for the following model and parts table.

5VDF – 8LDF SERIES

REF	DESCRIPTION	QTY	5VDF	5VSF	6LCF **	6HDK	7LDE	7HDD	7HDE	8HDM	8HDN	8LDF
1	INLET FILTER ASSEMBLY	2 4	B300F	B300F	B300F	B300A	B300F	B300A	B300A	B300F	B300F	B300F
2 Δ	FELT	2 4	B344A	B344A	B344A	B344A	B344A	B344A	B344A	B344A	B344A	B344A
3	SAFETY VALVE	1	-	-	AS100D	AS100G	AS100D	AS100G	AS100G	AS100F	AS100G	AS100B
4	CYLINDER HEAD	4/2 **	AF507	AF507	AF507	AF507	AF507	AF507	AF507	AF507	AF507	AF507
5 Δ	HEAD GASKET	4/2 **	AF520A	AF520A	AF520A	AF520A	AF520A	AF520A	AF520A	AF520A	AF520A	AF520A
6 Δ	OUTLET VALVE	4/2 **	AF545	AF545	AF545	AF545	AF545	AF545	AF545	AF545	AF545	AF545
7	PLATE VALVE	4/2 **	AF543	AF543	AF543	AF543	AF543	AF543	AF543	AF543	AF543	AF543
8 Δ	INLET VALVE	4/2 **	AF544	AF544	AF544	AF544	AF544	AF544	AF544	AF544	AF544	AF544
9 Δ	CYLINDER GASKET	4/2 **	AF521	AF521	AF521	AF521	AF521	AF521	AF521	AF521	AF521	AF521
10	CYLINDER	4/2 **	AF509	AF509	AF509	AF509	AF509	AF509	AF509	AF509	AF509	AF509
11 Δ	PISTON RING	8/4 **	AF541	AF541	AF541	AF541	AF541	AF541	AF541	AF541	AF541	AF541
12 Δ	PISTON SEAL	8/4 **	AF540	AF540	AF540	AF540	AF540	AF540	AF540	AF540	AF540	AF540
13	PISTON ROD ASSEMBLY	4/2 **	AF561F	AF561F	AF561F	AF561K	AF561E	AF561D	AF561E	AF561M	AF561N	AF561F
14 Δ	RIDER RING	4/2 **	AF595	AF595	AF595	AF595	AF595	AF595	AF595	AF595	AF595	AF595
15	MANIFOLD	1	AF659	AF659	-	AF659	AF659	AF659	AF659	AF659	AF659	AF659
16	SQUARE KEY	2/1 **	AB136F	AB136F	AB136F	AB136F	AB136F	AB136F	AB136F	AB136F	AB136F	AB136F
17	FAN/FAN ASSEMBLY-CCW	1	AF748	AF748	AF748	AF748	AF748	AF748	AF748	AF748	AF748	AF748
18	FAN ASSEMBLY-CW	1	AF747	AF747	AF747	AF747	AF747	AF747	AF747	AF747	AF747	AF747
19	SHROUD	2/1 **	AF656	AF656	AF656	AF656	AF656	AF656	AF656	AF656	AF656	AF656
20	MANIFOLD SLEEVE	2	-	-	AF567A	-	-	-	-	-	-	-
20	MANIFOLD SLEEVE	5	AF567A	AF567A	-	AF567A	AF567A	AF567A	AF567A	AF567A	AF567A	AF567A
21	TANK ASSEMBLY	1	-	-	AF606-1	AF606-1	AF606-1	AF606-1	-	AF606-1	AF606-1	-
22	MANIFOLD	2/1 **	AF550E	AF550E	AF550E	AF550C	AF550D	AF550D	AF550D	AF550A	AF550A	AF550E
***	SERVICE KIT	1	K303	K303	K263	K303	K303	K303	K303	K303	K303	K303

Model 5VDF shown.

** 6LCF is a two-cylinder unit. Other models are four-cylinder units.

*** Item not shown.

Δ Denotes parts included in the Service Kit.

Parts listed are for stock models. For specific OEM models, please consult the factory.

When corresponding or ordering parts, please give complete model and serial numbers.

EXPLODED PRODUCT VIEW - MODEL 5VDF

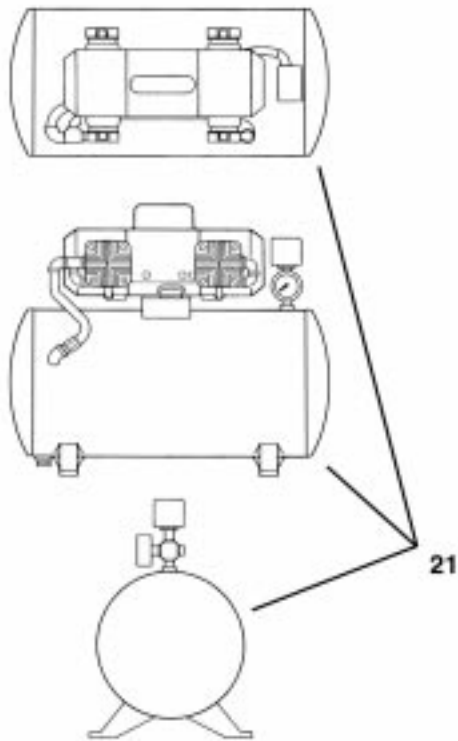
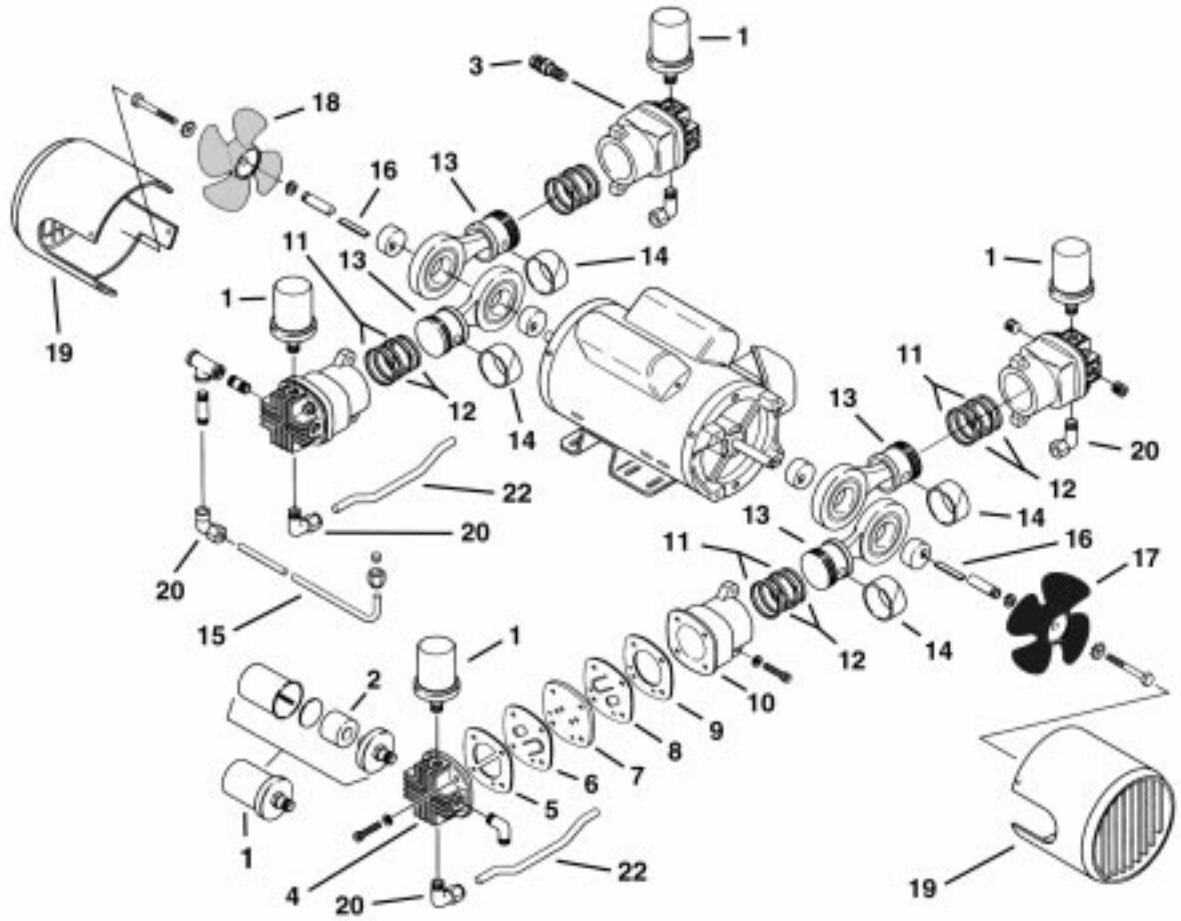

TROUBLESHOOTING CHART

Low		High		Pump Overheat	Motor Overload	Excess Noise	Reason and remedy for problem.
Vacuum	Pressure	Vacuum	Pressure				
	•			•	•	•	Filter dirty. Clean or replace.
•			At pump	•	•	•	Muffler dirty. Clean or replace.
•	•					•	Valves dirty or valves bent. Clean or replace.
•	•					•	Damaged or worn piston rings. Repair or replace.
	•			•	•		Leaky relief valve. Inspect and adjust.
•	•					•	Damaged valves. Replace.
•		At pump	•	•	•	•	Plugged vacuum/pressure line. Inspect and repair.
•	•			•	•		Low voltage, won't start. Check power source.
•	•					•	Worn rings/piston hitting cylinder. Replace.
	•			•	•	•	Cylinder misadjustment. Realign.
•	•					•	Leaky hose or check valve. Replace.
•	•			•	•	•	Dirt or liquid on top of piston. Inspect and clean.
•	•					•	Blown head gasket. Replace.

We have Gast Authorized Repair Facilities throughout the world. For the most up-to-date listing, contact one of our sales offices below:

World Headquarters

P.O. Box 97
2550 Meadowbrook Rd.
Benton Harbor, MI 49023-0097
Ph: 269/926-6171
FAX: 269/925-8288
www.gastmfg.com

**European Sales & Service
Headquarters**

Beech House Knaves Beech
Business Centre
Loudwater, High Wycombe Bucks,
England HP10 9SD
Tel: +44 1628 551500
Fax: +44 1628 551590
www.gastmfg.com

Gast Hong Kong

Unit 12, 21/F, Block B
New Trade Plaza
6, On Ping Street, Shatin
N. T. Hong Kong
Ph: (852) 2690 1008
Fax: (852) 2690 1012
www.gasthk.com



ISO 9001 & 14001 CERTIFIED

www.gastmfg.com